

**DO NOT SCALE DRAWINGS.**

CONTRACTOR MUST VERIFY ALL DRAWINGS, DIMENSIONS, DETAILS AND SPECIFICATIONS, AND REPORT ANY DISCREPANCIES TO UNION 31 INC. BEFORE PROCEEDING WITH WORK. MATERIALS MAY NOT BE SUBSTITUTED WITHOUT WRITTEN APPROVAL FROM UNION 31 INC.  
ALL DRAWINGS AND SPECIFICATIONS ARE INSTRUMENTS OF SERVICE AND THE PROPERTY OF UNION 31 INC. WHICH MUST BE RETURNED AT THE COMPLETION OF THE WORK.

PRINTED: 25-F40-15

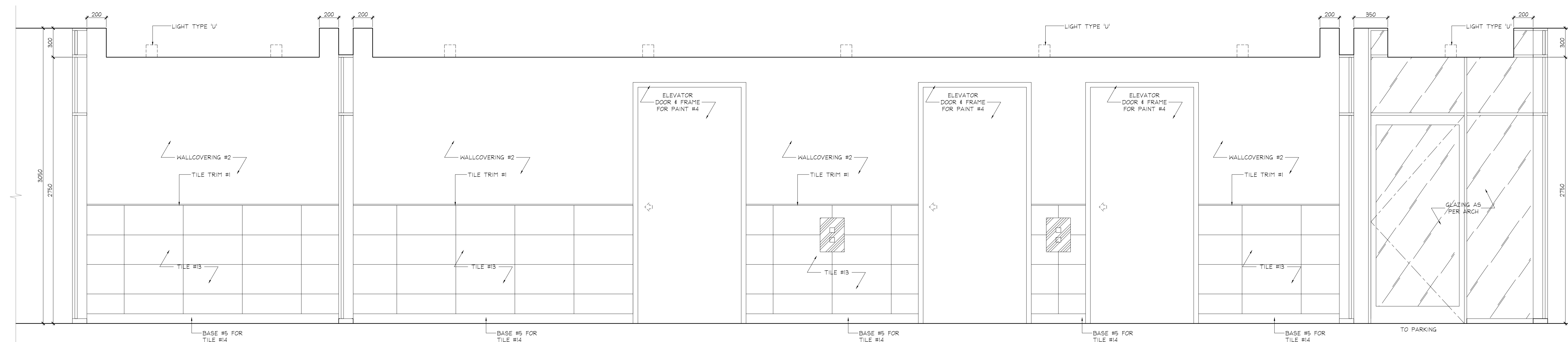

**1 ELEVATION**  
ID2.0.1 P1 LEVEL  
ELEVATOR LOBBY SCALE 1:20

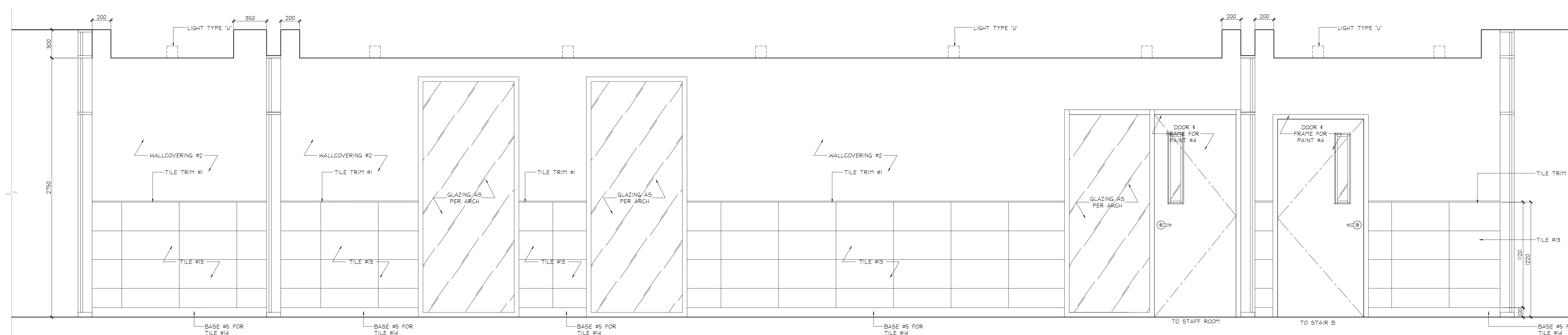

**2 ELEVATION**  
ID2.0.1 P1 LEVEL  
ELEVATOR LOBBY SCALE 1:20

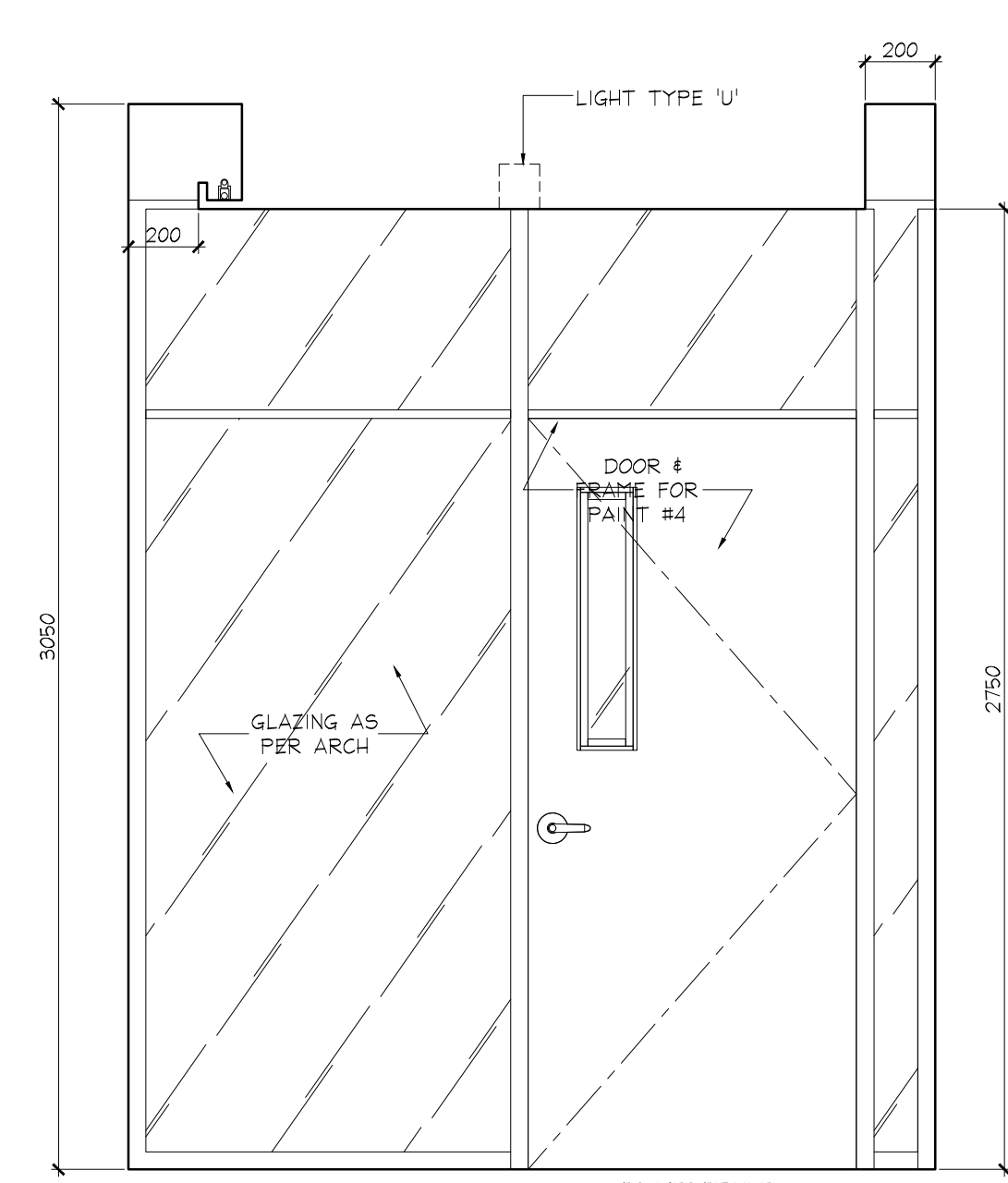

**3 ELEVATION**  
ID2.0.1 P1 LEVEL  
ELEVATOR LOBBY SCALE 1:20

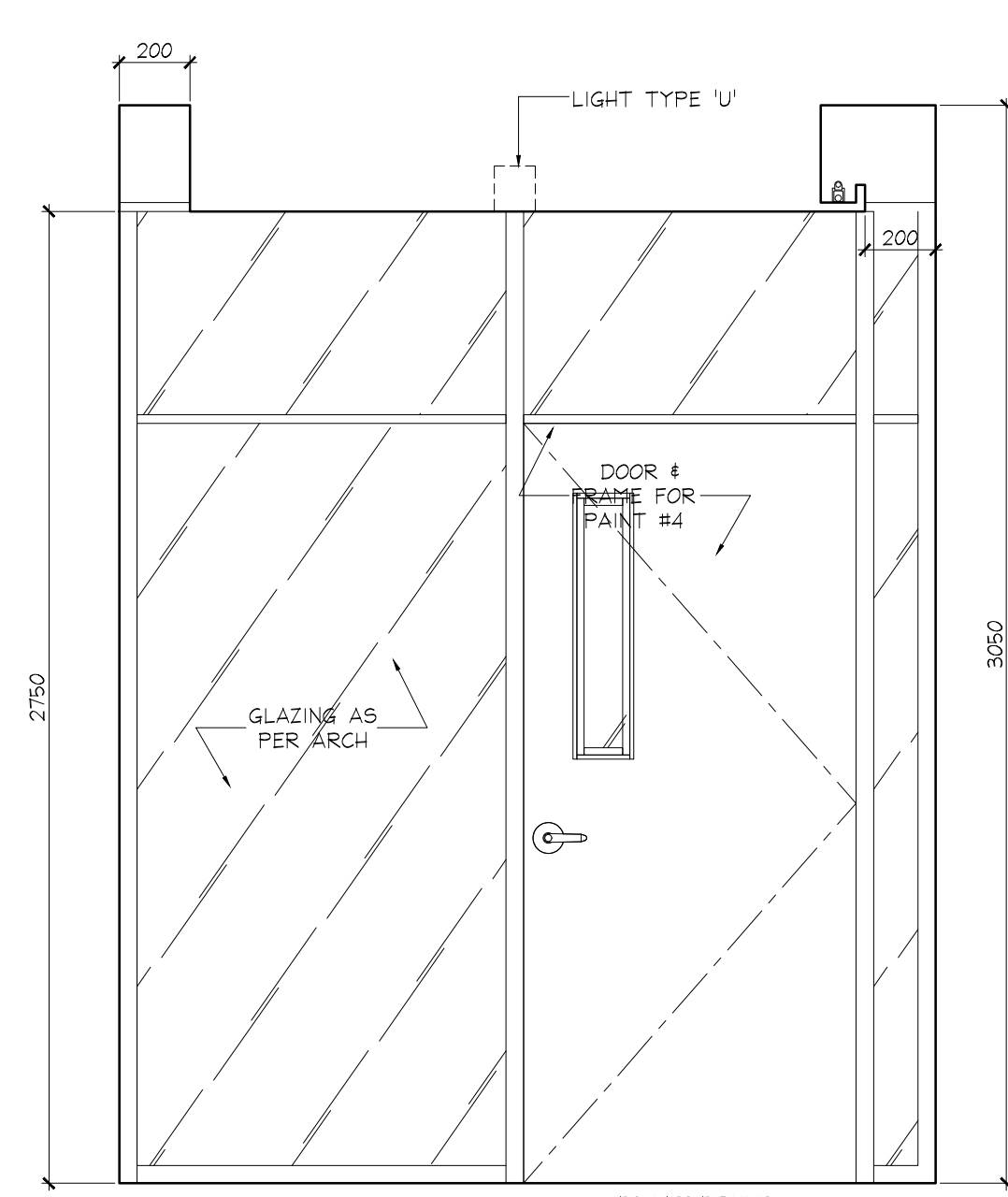

**4 ELEVATION**  
ID2.0.1 P1 LEVEL  
ELEVATOR LOBBY SCALE 1:20

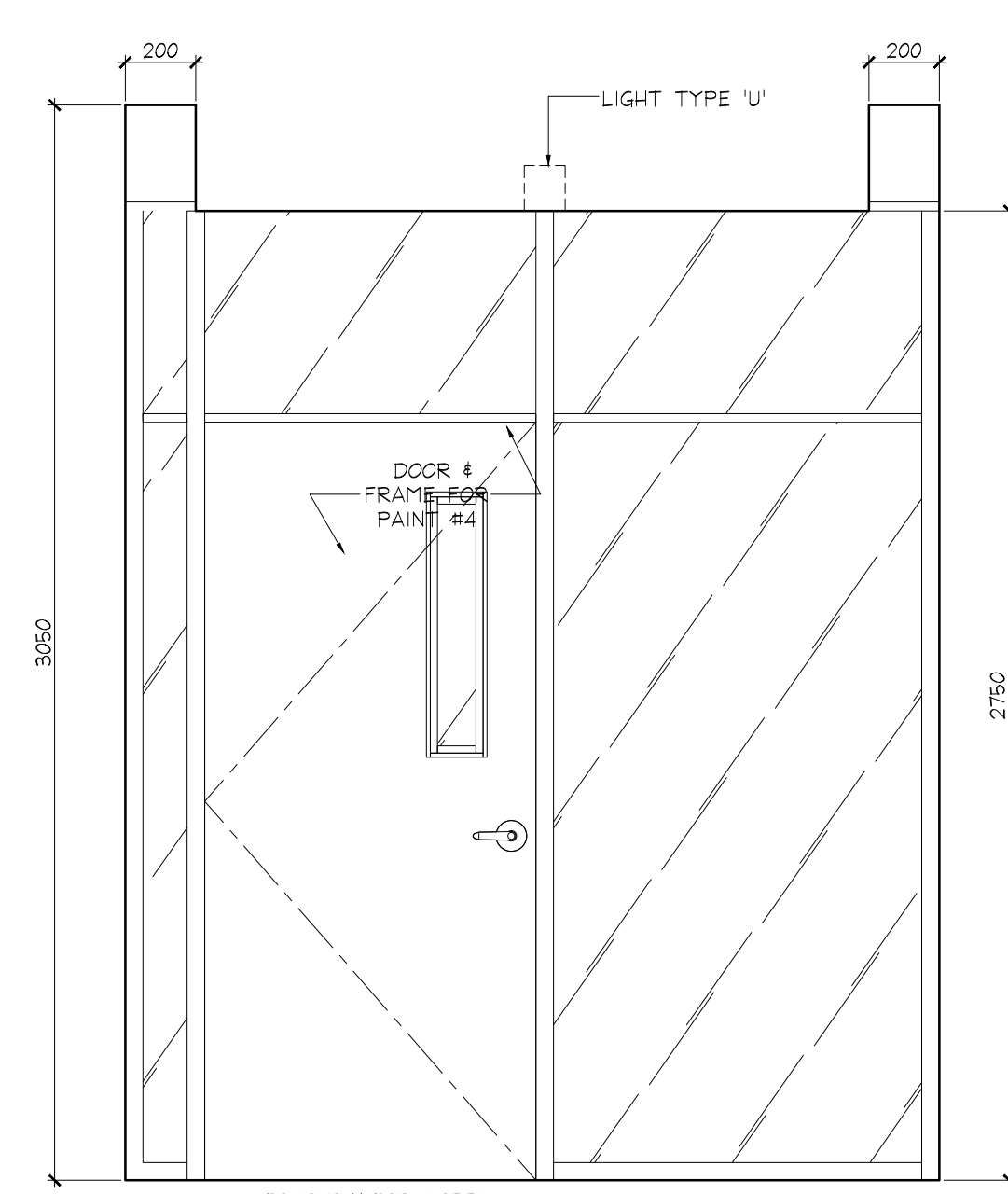

**5 ELEVATION**  
ID2.0.1 P1 LEVEL  
VESTIBULE SCALE 1:20

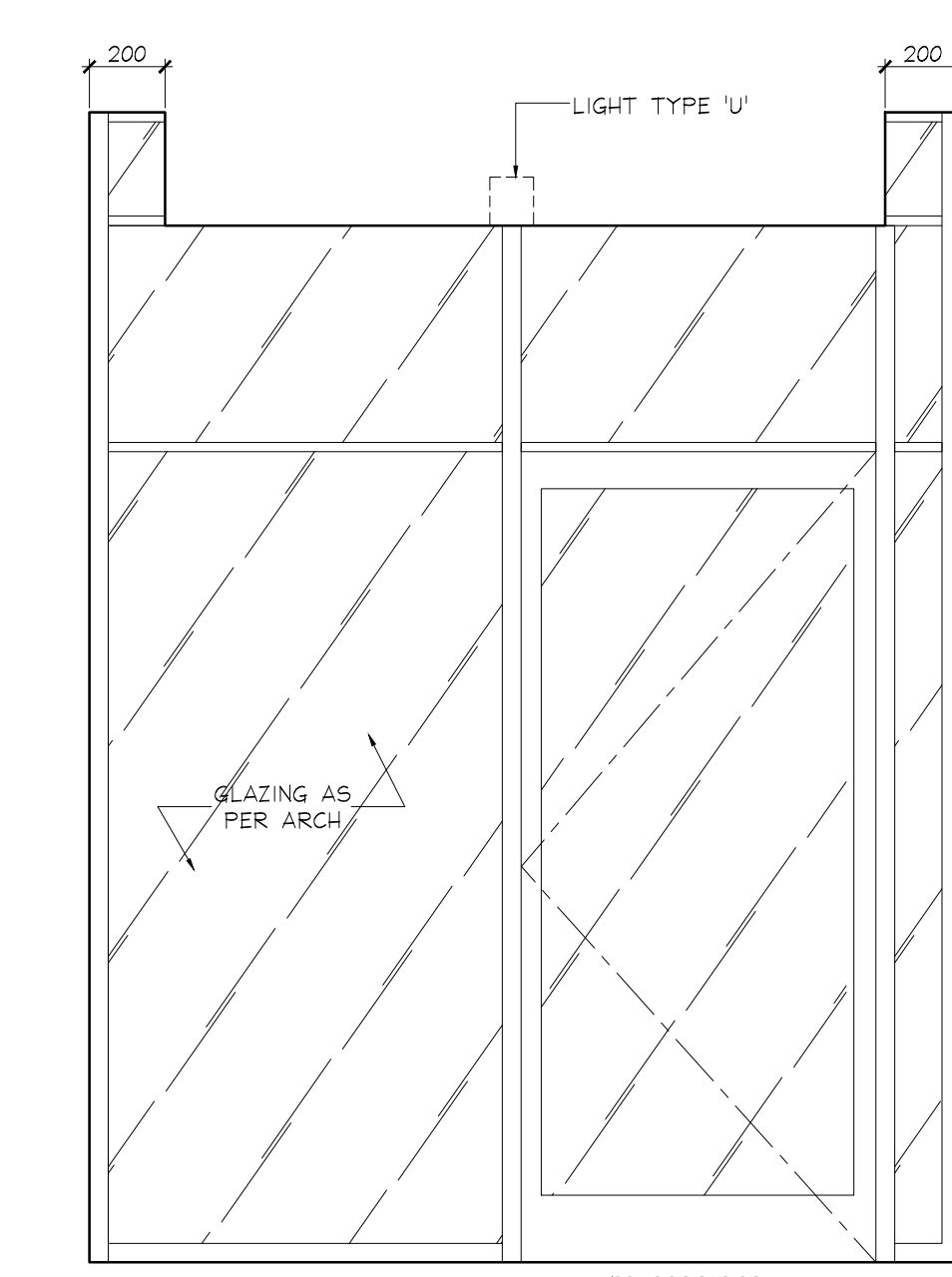

**6 ELEVATION**  
ID2.0.1 P1 LEVEL  
VESTIBULE SCALE 1:20

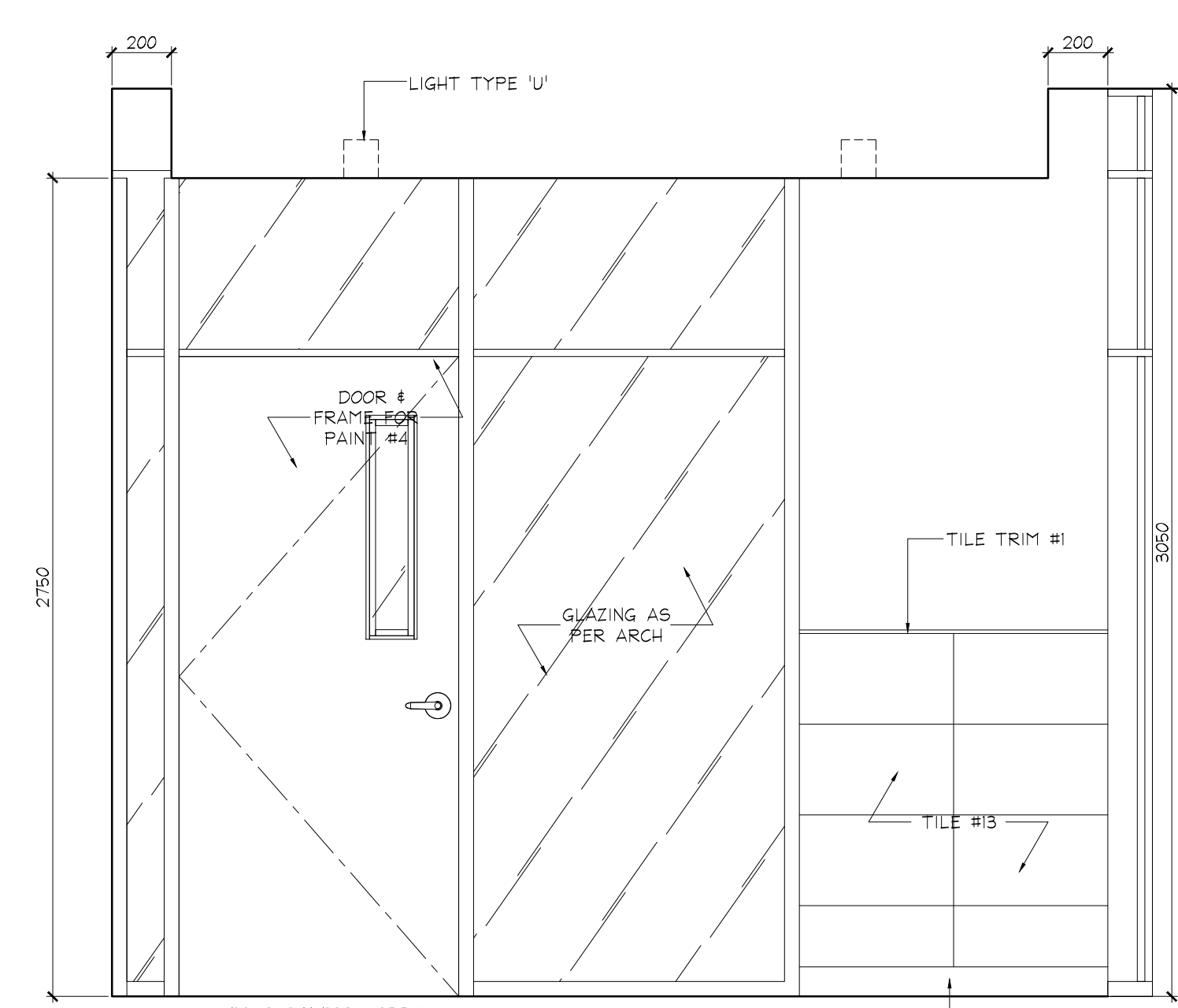

**7 ELEVATION**  
ID2.0.1 P1 LEVEL  
VESTIBULE SCALE 1:20

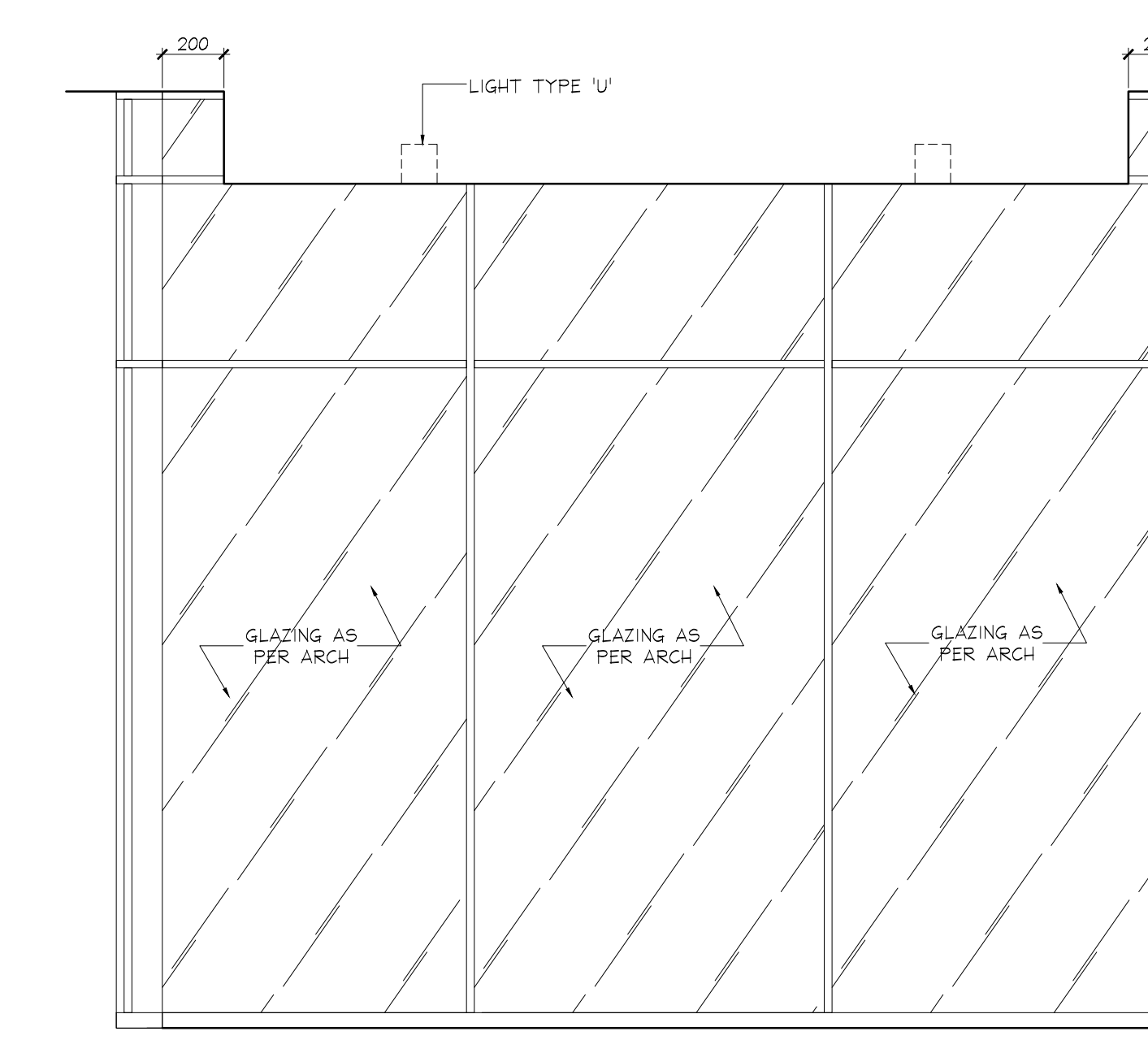

**8 ELEVATION**  
ID2.0.1 P1 LEVEL  
VESTIBULE SCALE 1:20

NO.	DATE	COMMENTS	INI
03	26 FEB / 15	ISSUED FOR TILE TENDER	AP
02	26 JAN / 15	ISSUED FOR TENDER	AP
01	22 AUG / 14	ISSUED FOR PERMIT	AP

**UNION 31**

UNION31 INC.  
183 BATHURST STREET, STE. 201  
TORONTO, ON, M5T 2R7, CANADA  
TEL: 416-597-1576 FAX: 416-597-2139

PROJECT NAME:  
**ALEXANDRA PARK  
MAIN BUILDING**  
BLOCK 11  
ON, Canada  
PROJECT NO.:  
13-949  
DRAWINGS:

**PARKING LEVEL  
ELEVATIONS**

DATE STARTED: 07 AUG / 13	DRAWING NO.:
SCALE: 1:20	<b>ID</b>
DRAWN BY: AP	<b>2.0.1</b>
APPROVED BY: KC	